

## Modellübersicht

---

- 250 Quadcopter Frame Kit Pure Carbon Fiber (1 set) ( Three color:Random)
- 6030 Carbon fiber propellers 2 pairs (CW+CCW)
- MT2204-2300KV (2pcs CW and 2pcs CCW)
- Simon ESC 12A(4pcs)
- CC3D flight controller (1pcs)













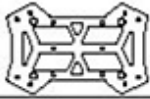
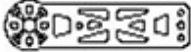

## Frame

---



# Frame Description

## 1. Part list

1. Rubber shock absorption ball retaining board (1PCS) 	2. Frame upper board (1PCS) 	3. Frame center board (1PCS) 	4. Frame lower board (1PCS) 
5. Frame arm (4PCS) 	6. Camera Lens holder (1PCS) 	7. H20 Aluminum post (4PCS) 	8. H35 Aluminum post (6PCS) 
9. H5 Aluminum post (8PCS) 	10. Screw M3*8 (5PCS) 	11. Screw M3*6 (29PCS) 	12. Screw M3*16 (9PCS) 
13. Screws M2*5.5 (17PCS) 	14. Rubber shock absorption ball (5PCS) 	15. self-locking nut (9PCS) 	16. nylon screw M3*6 (5PCS) 

## 2. Frame structure overview

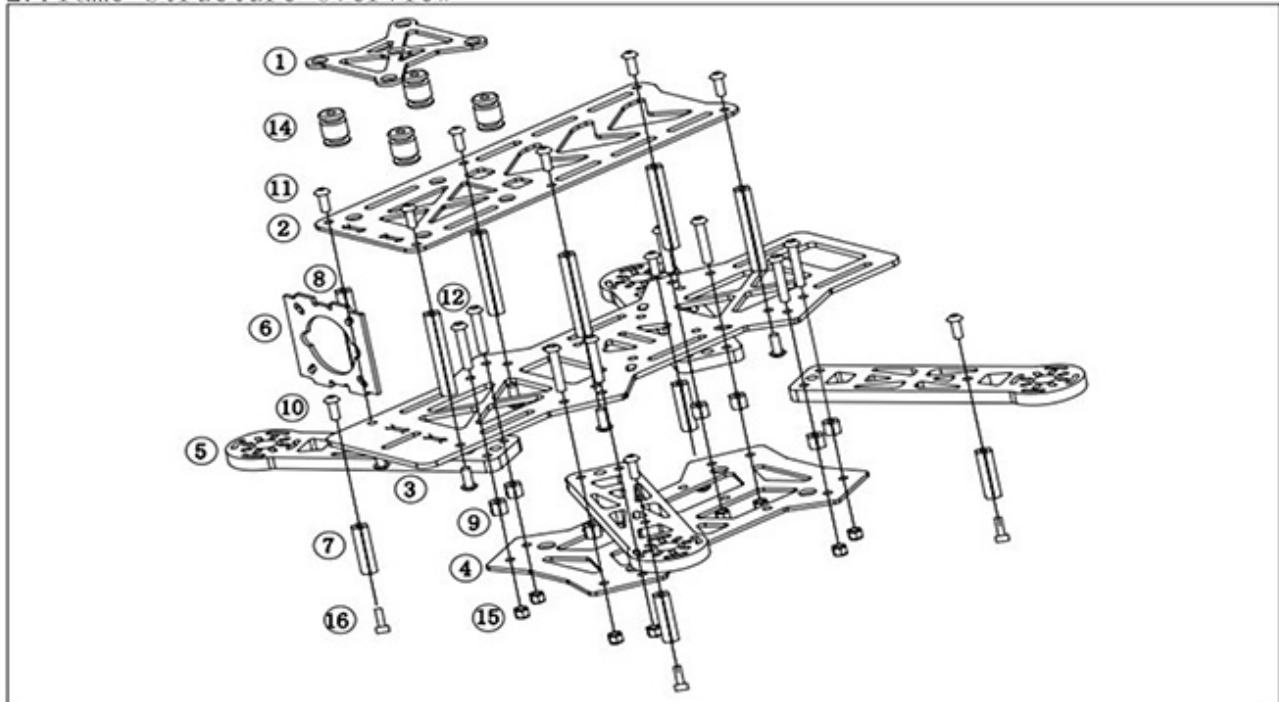

## 3. Specifications:

Wheelbase: 280 (+/-3mm)  
 Height: 72 (+/-3mm)  
 Weight: 129g

Note: Each screw an self-locking nut and Rubber shock absorption ball one more.

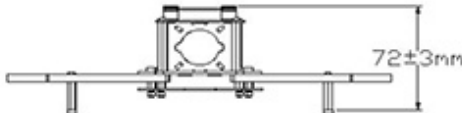

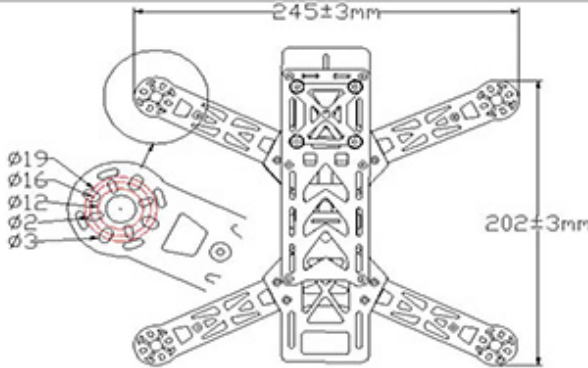

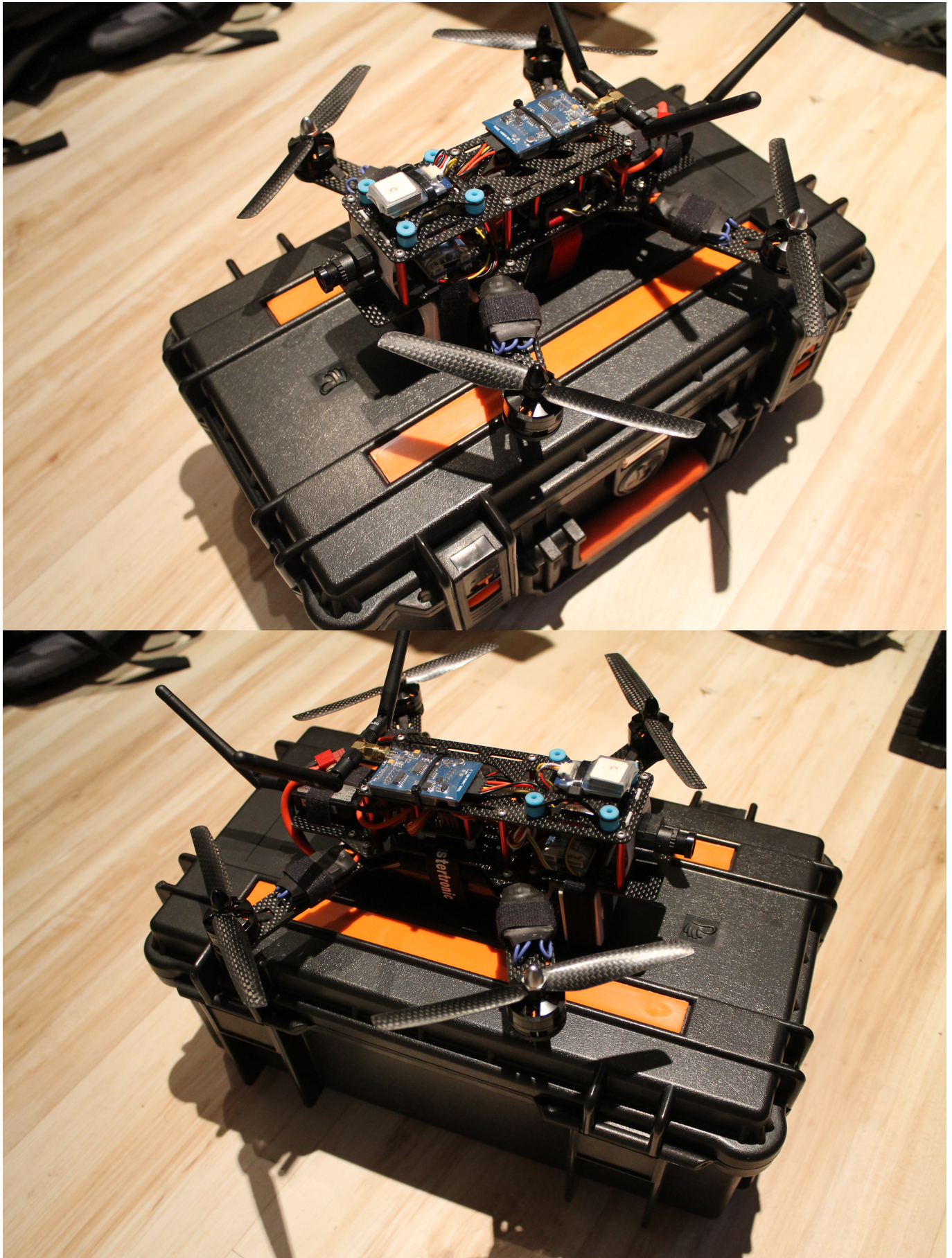

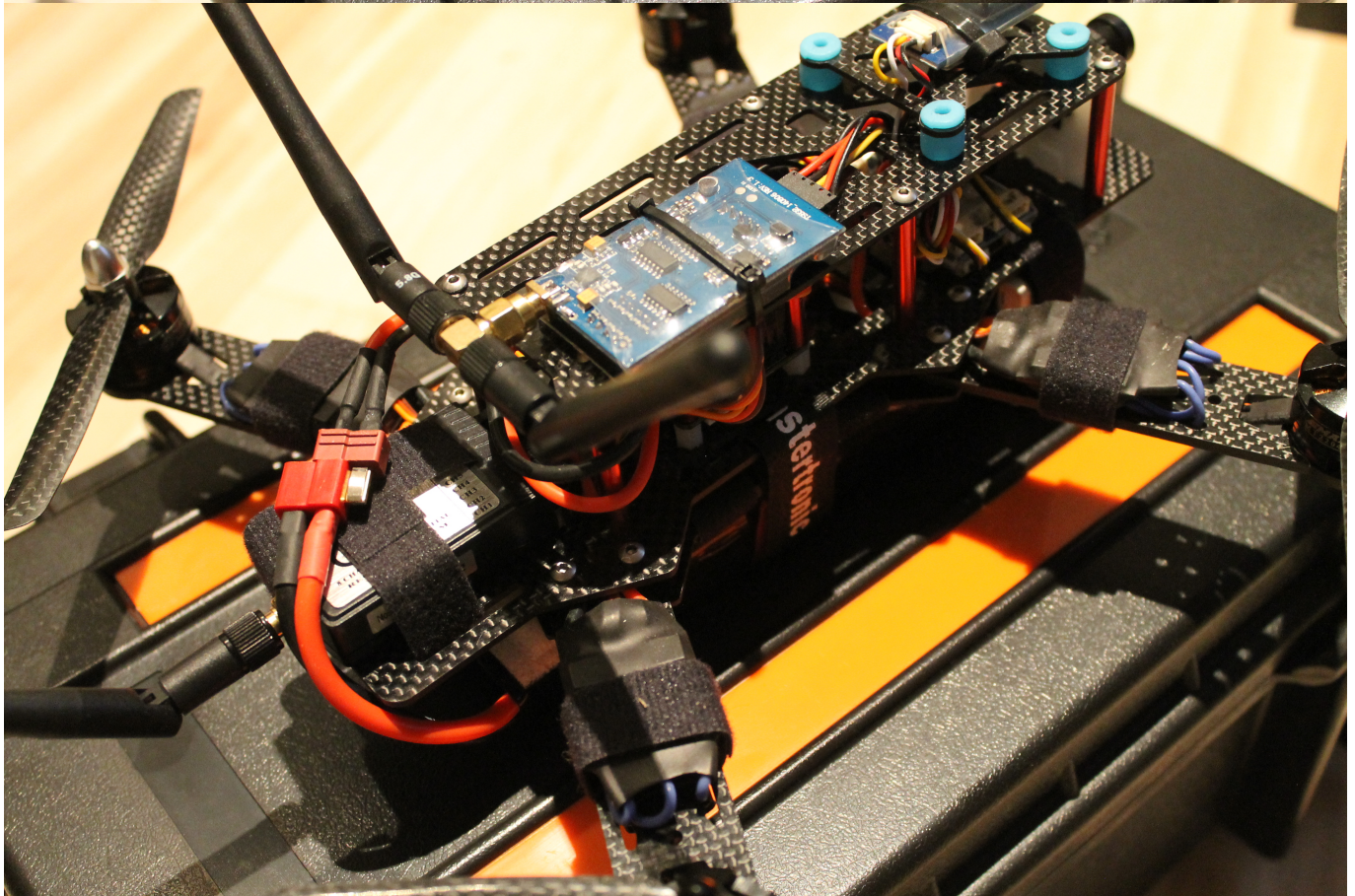
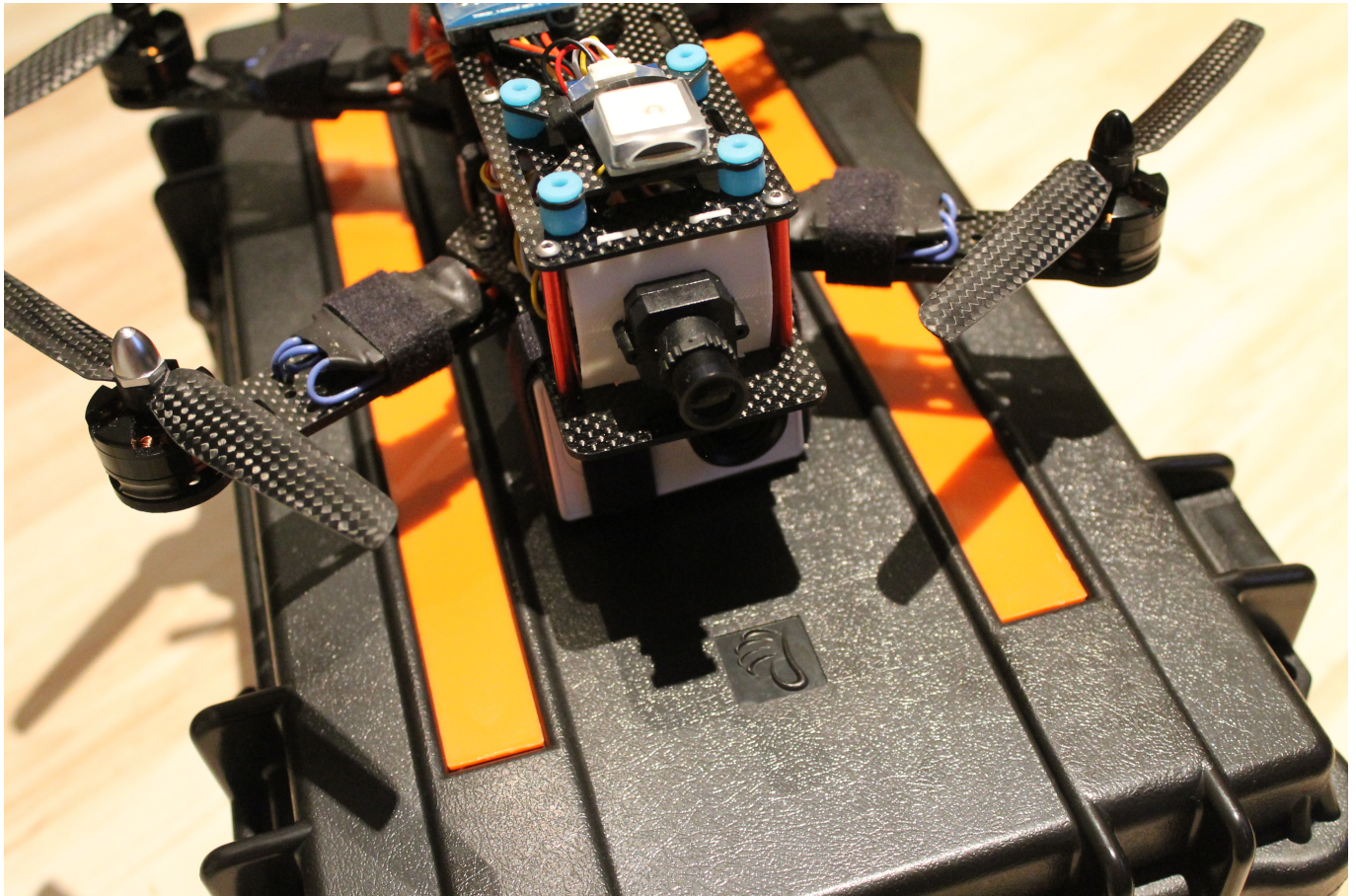

**Dauerhafter Link zu diesem Dokument:**

<https://wiki.technikkultur-erfurt.de/projekte:quadrocopter:nighthawk250>

Dokument zuletzt bearbeitet am: **23.07.2015 00:06**



**Verein zur Förderung von Technikkultur in Erfurt e.V**

<https://wiki.technikkultur-erfurt.de/>